

As a result of the world leaders experience, the GYSPOT INVERTER PTI-G is the spot welder of the future. The on-board intelligence guarantees full automation, offering bodyshops the ability to increase their efficiency: Genius G-clamp with pneumatic over-opening, easy arm positioning without adjustment, motorised overhanging arm providing a wide working area. It is the most advanced machine for the active bodyshop. It is the most advanced machine for the active bodyshop.



Innovative clamp with integrated transformer

- **Light weight** of 11.3 kg with the G1 arm.
- **80 mm of automatic opening** capacity (20 mm at rest)
- Manual **over-opening** of the arm for access to difficult areas (200 mm release).
- Brass clamp support and arm-base for an optimal electrical contact (effortless maintenance).
- The double action feature ensures a **quick arm removal** without the use of tools.
- Automatic cooling connection.
- Remote controlled clamp (opening, welding, adjustments validation).
- **Lockable Gyroscope**, ball bearing, integrated into the clamp body.
- **High duty cycle** (18 points/min).
- Optional G9 arm suitable with auto mode.
- Optional single-point gun (option).

ADJUSTABLE OVERHANGING ARM

- **Extends 120cm** from the power source
- **Motorised overhanging** arm to adapt the working height.
- **Offset balancer** from the work area.
- Rubber **protections** at the end of moving parts.

SMART WELDING

- **AUTO Mode:** the machine automatically recognizes - steel type, sheet-metal thickness, Panel bond presence and insulating material between HSS/VHSS/UHSS/Boron sheet-metal.
- **Traceability:** The recording feature saves the characteristics of each welding spot performed to the SD card provided
- Easy transfer of saved reports to PC.

HIGH PERFORMANCE

- Welding current: 14 500 A.
- Clamping force: 550 daN with 8 bar air pressure.
- Liquid cooling of the entire transformer, rectifier, electrodes and caps.
- The new design of the G-clamp cylinder and welding algorithm maximises productivity
- User friendly navigation using the 5.7» LCD screen.
- Automatic adjustment of the pressure between electrodes.
- Spot count feature to determine when you need to change the caps.

ROBUST AND MOBILE

- Reinforced and manoeuvrable trolley with 30-litre coolant tank.
- Expander on the front wheels for better stability.
- Integrated 6-arm support.



6 m long cable

Supplied with:
G1 arm, motorised overhanging arm with pulley (See next page)

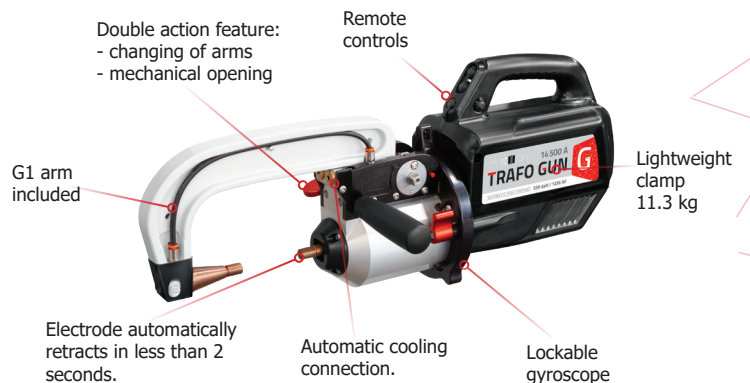

Double action feature:
- changing of arms
- mechanical opening

Remote controls

G1 arm included

Lightweight clamp
11.3 kg

Electrode automatically retracts in less than 2 seconds.

Automatic cooling connection.

Lockable gyroscope

50/60Hz	50 A (D)	I RMS A	U ₀ V	mm		8m 4xAWG8 (SOOW)	71 x 90 x 200 cm	100 kg	IP 20
				⚡	🔧				
200 V	50 A (D)	12 500 A	6.6 V	2.5 + 2.5 + 2.5	1.5 + 3	8m 4xAWG8 (SOOW)	71 x 90 x 200 cm	100 kg	IP 20
208 V		13 000 A	6.9 V						
220 V		14 500 A	7.3 V						
240 V		14 500 A	7.9 V						

AN EXCEPTIONALLY LONG, EFFICIENT AND ADJUSTABLE OVERHANGING ARM

Easy to handle, adjustable and motorised, the new overhanging arm allows the height to be adapted to all working conditions.

- Very wide working area
- Extends 120 cm from the power source.
- Rotates up to 30°.
- Foldable to optimise space



ISOLATED ARMS (OPTIONS)

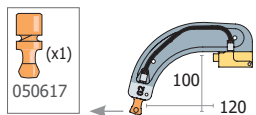

G2 - 8 bar/300 daN
022775

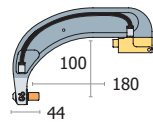

G6 - 8 bar/550 daN
022812

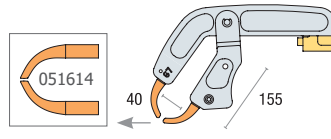

G7 - 4 bar/150 daN
022829

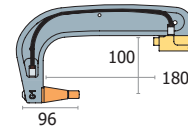

G1 - 8 bar/550 daN
022768

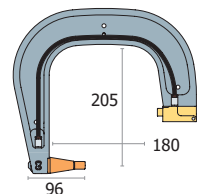

G3 - 8 bar/550 daN
022782

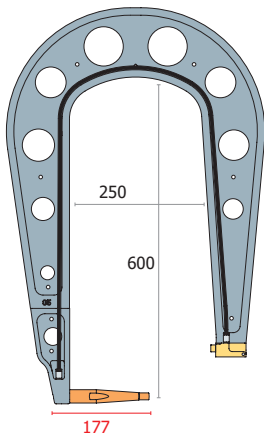

G5 - 8 bar/550 daN **⚖ : 6.25 kg**
022805

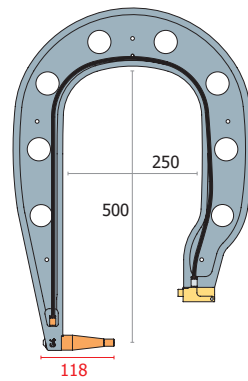

G4 - 8 bar/550 daN
022799

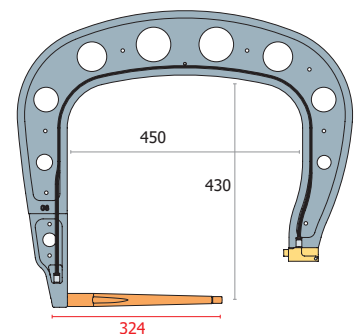

G8 - 8 bar/550 daN
022836

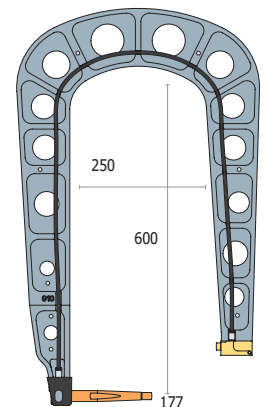

G10 - 8 bar/400 daN **lighten** **⚖ : 5 kg**
067165

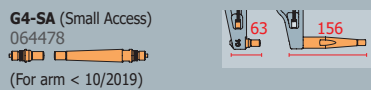

G4-SA (Small Access)
064478
(For arm < 10/2019)

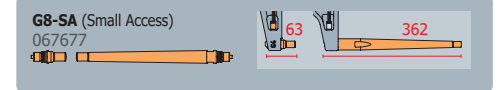

G8-SA (Small Access)
067677



G5-G10-SA (Small Access)
067660

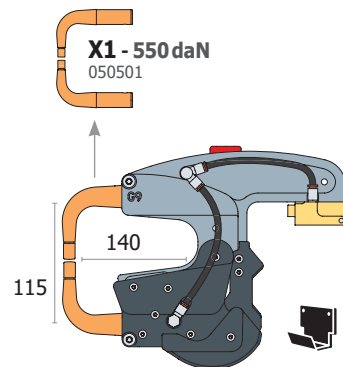

G9 + X1 - 550 daN - 022881

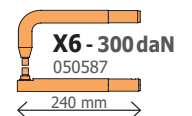

X6 - 300 daN
050587

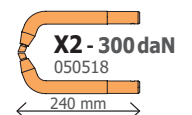

X2 - 300 daN
050518